



TRAUMA

UNYCO GALAXY

One Giant Leap For Damage Control Orthopaedics



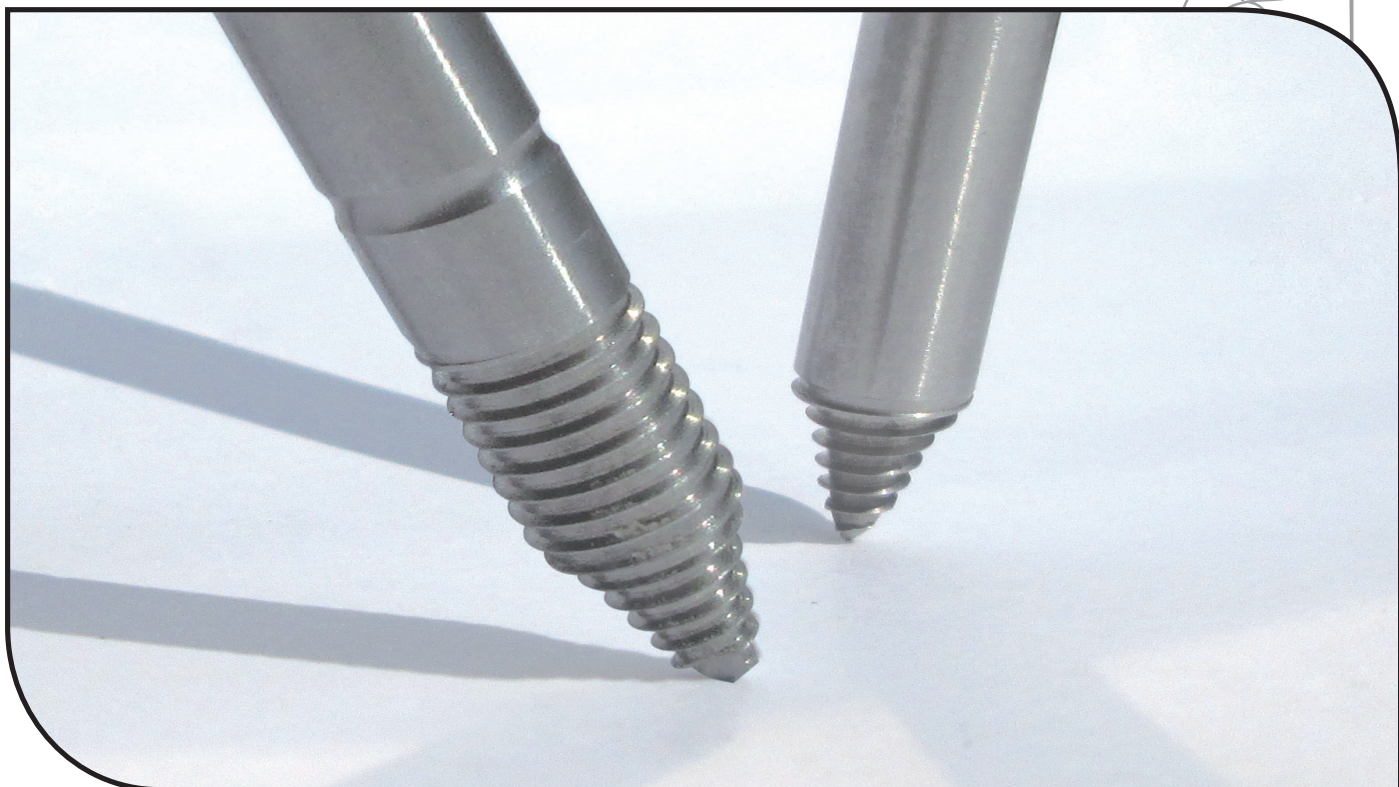

**Minimal
invasiveness**

Designed to
**avoid contamination
of the medullary canal**

The System is **MRI Conditional** at 1.5 and 3 Tesla
(refer to PQ MCS)



UNY **GALAXY**

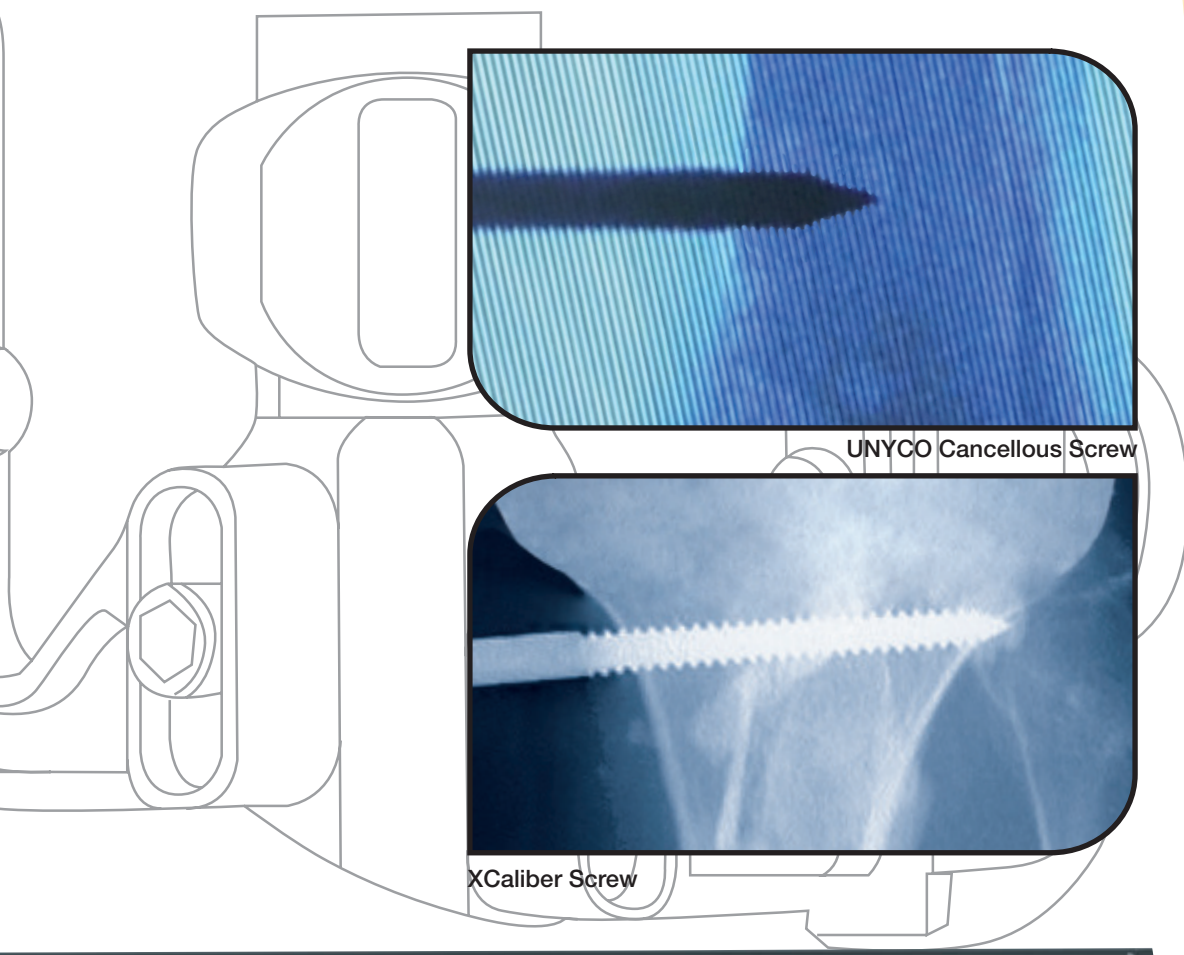

UNYCO Cancellous Screw

XCaliber Screw

Conceived for
**easier conversion
from temporary
to definitive fixation**

**Reduced
exposure
to X-rays**

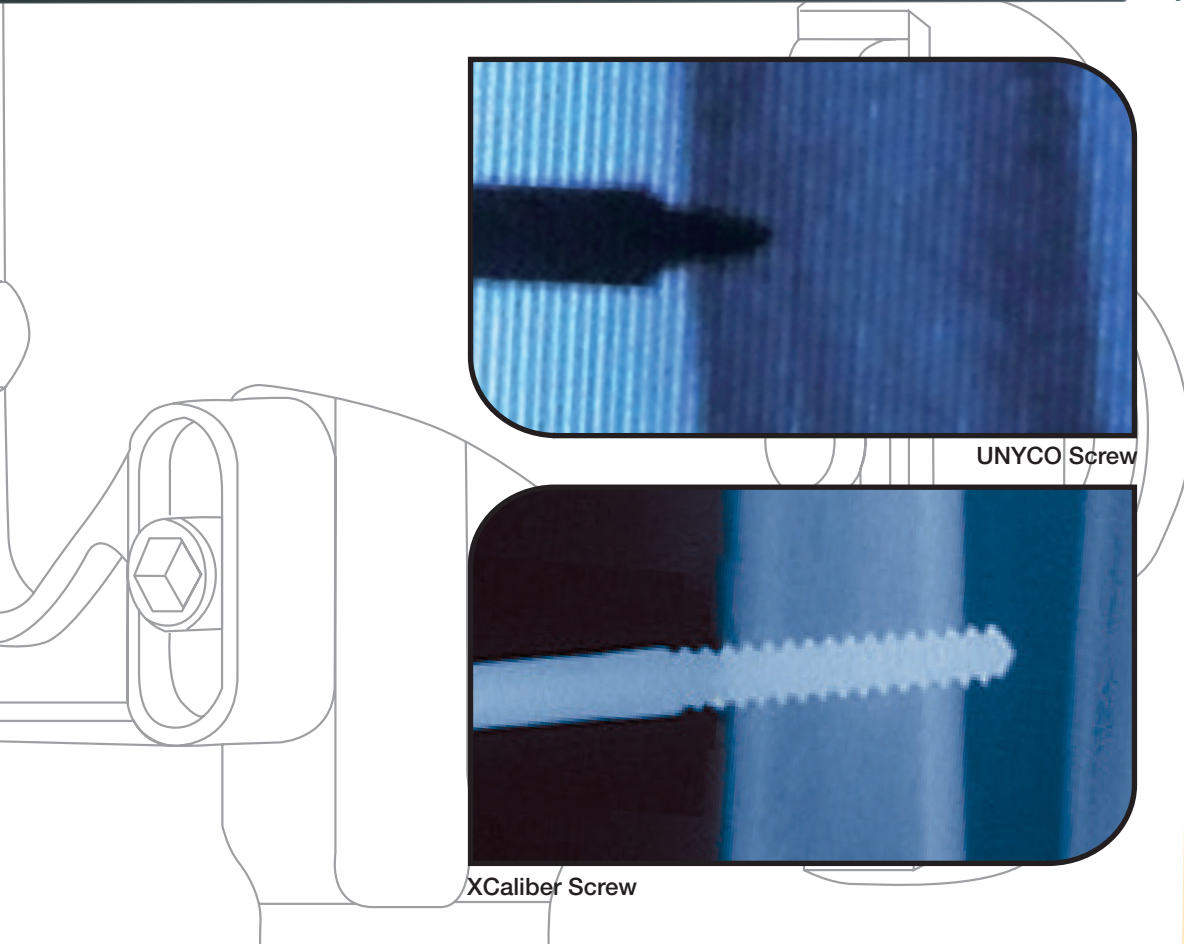
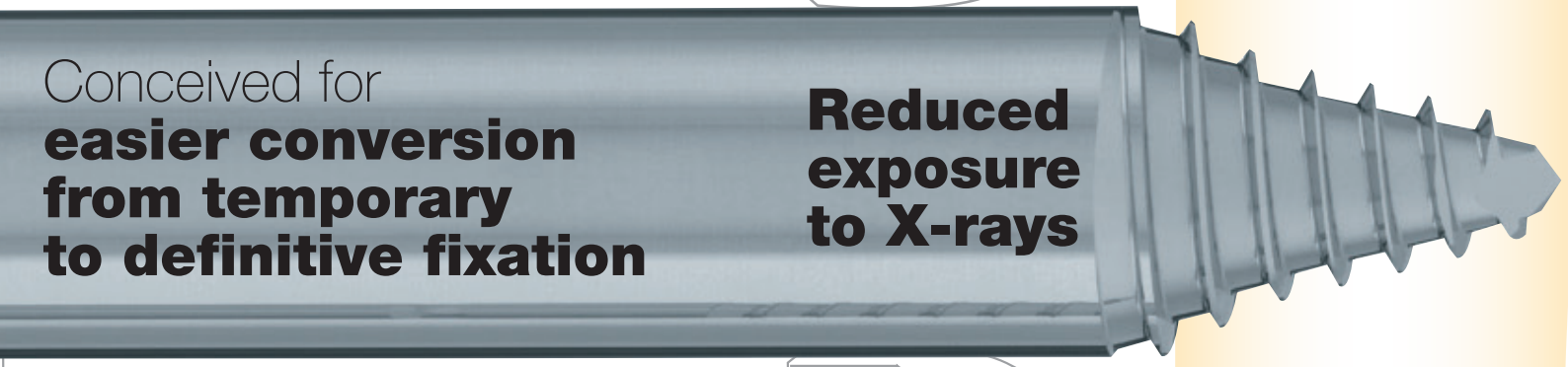

UNYCO Screw

XCaliber Screw

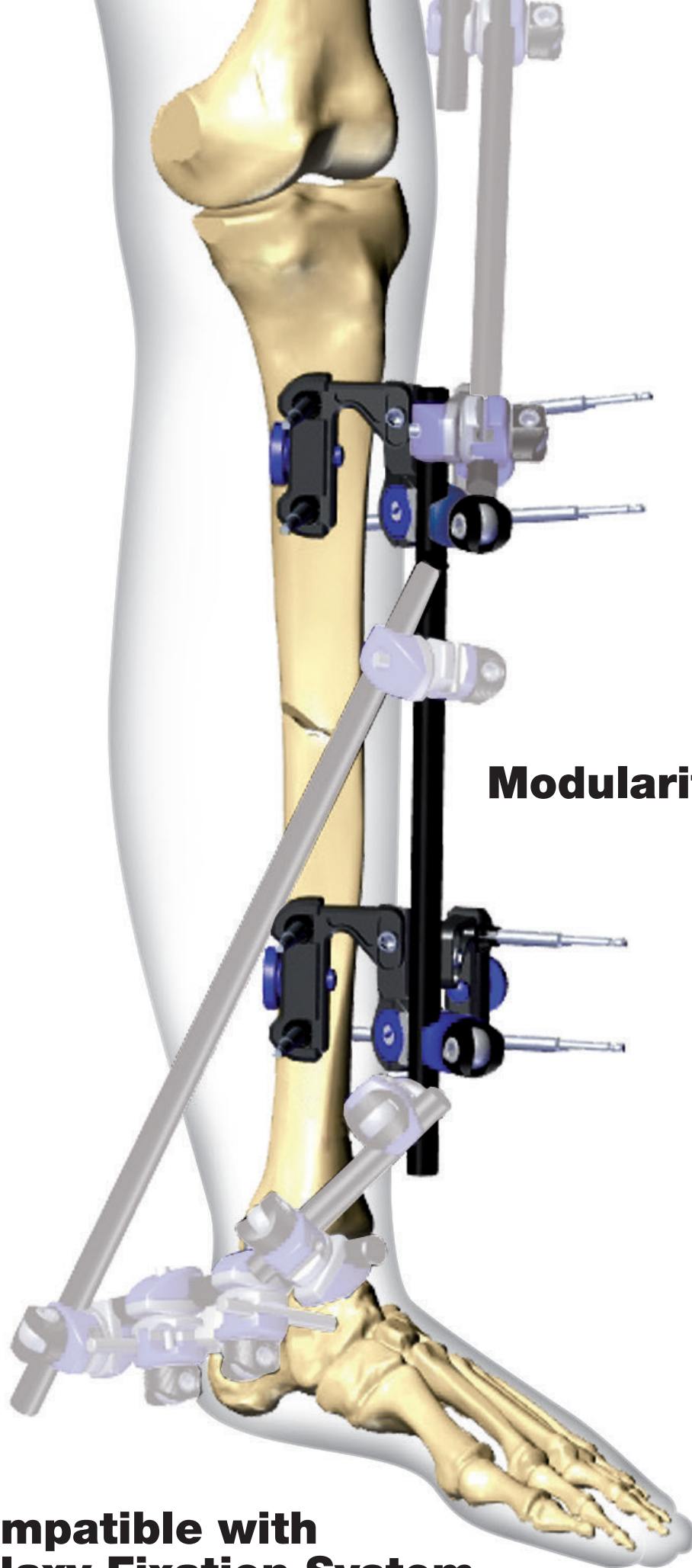

Modularity

**Compatible with
Galaxy Fixation System**
for spanning knee and ankle

STABILITY

Clustering of minimum 3 UNYCO screws per clamp

FAST LOCKING

Bar snap in and pre-closure by hand; definitive locking in one step

VERSATILITY

Same clamp, two configurations for different fracture patterns

EASE OF USE

Torque limited insertion for optimal screw application

FLEXIBILITY

$\pm 10^\circ$ polyaxial movement

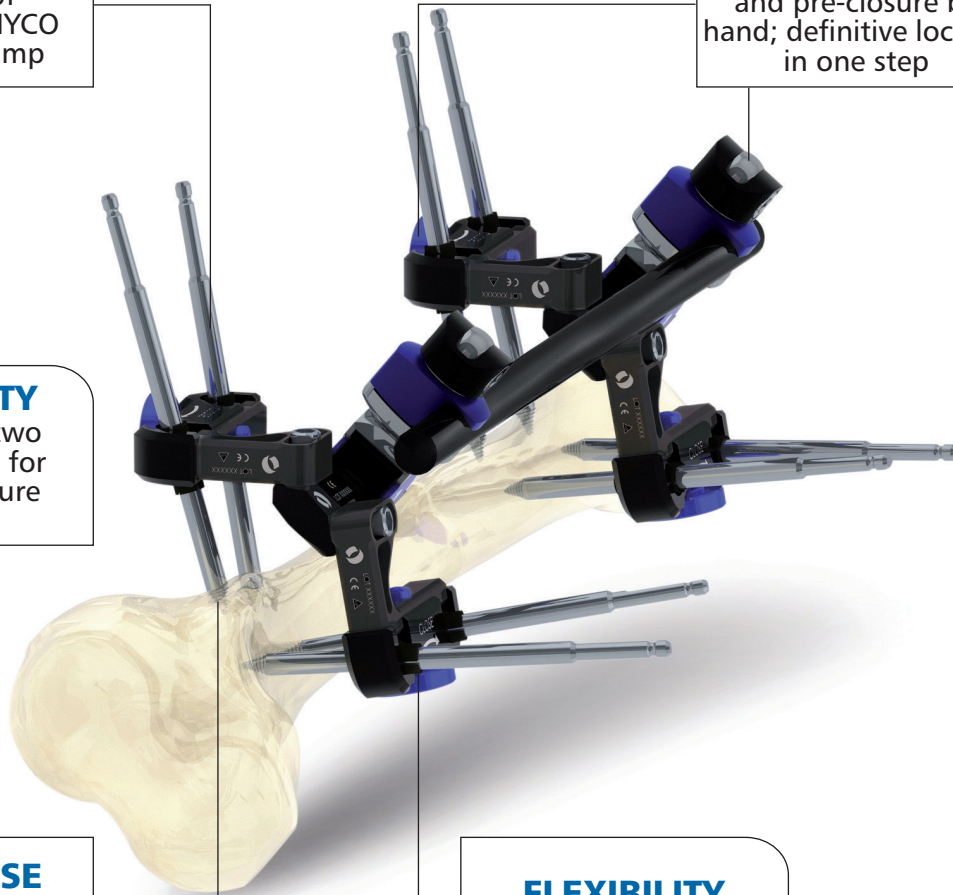

UNYCO CANCELLOUS SCREW



Quick Connect

Reference Line

\varnothing 6mm Shank

UNYCO SCREW



BICORTICAL SCREW

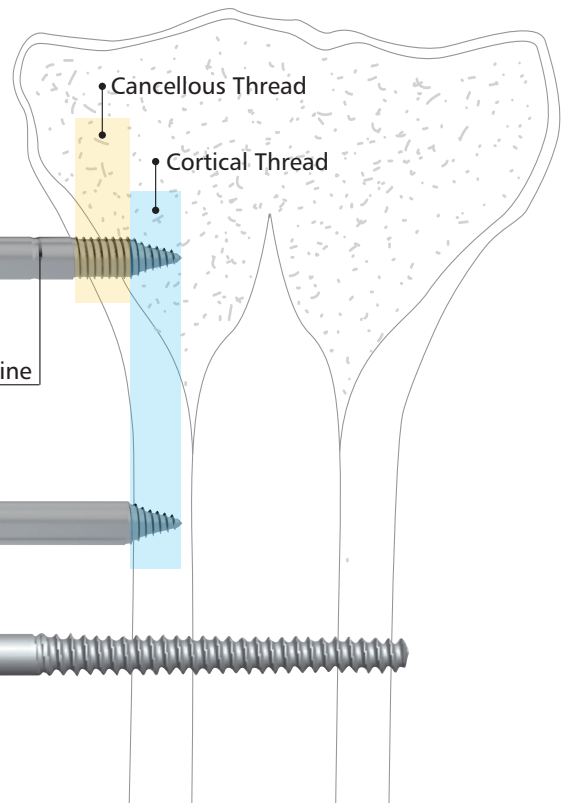

Cancellous Thread

Cortical Thread

Ideal for Damage Control Orthopaedics

in ready-to-use sterile kit

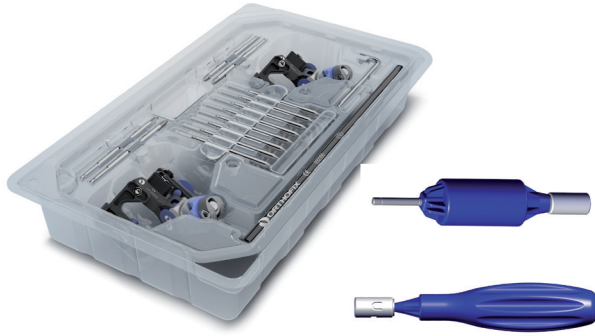

Galaxy UNYCO Diaphyseal Tibia Sterile Kit (99-93506)

- 2x Large Multiscrew Clamp for UNYCO Screws
- 1x Rod Ø 12mm L 350mm
- 8x UNYCO Screw QC Shaft Ø 6mm
- 4x UNYCO Cancellous Screw QC Shaft Ø 6mm
- 1x Allen Wrench 5mm
- 1x Power Drill Torque Limiter

99-93567 Limited Torque Wrench (out of kit, available upon request)

MECHANICAL TESTS

Internal tests on bone analog show that Galaxy UNYCO has great mechanical performance. When tested, these two frame configurations showed the minimum and maximum value of mechanical performance. All other possible frame configurations with Galaxy UNYCO Diaphyseal Tibia Sterile Kit gave results within this range of values.

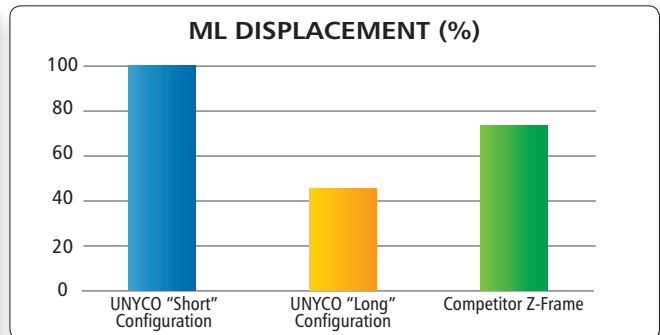
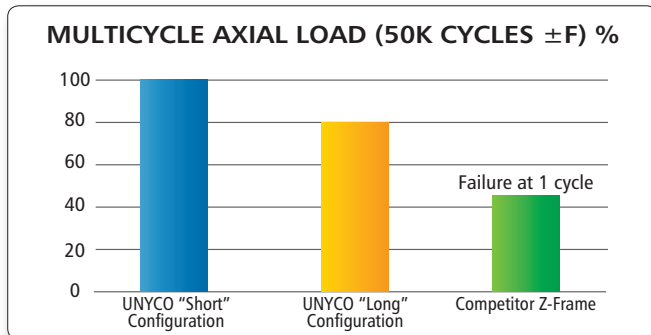
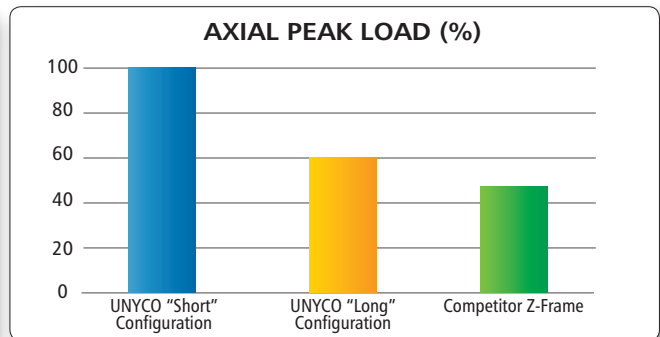
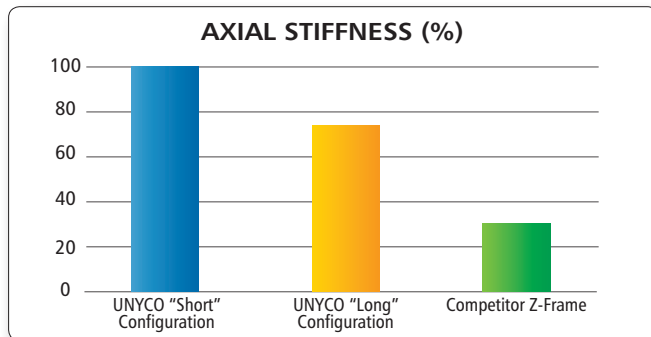

1. Galaxy Unyco "Short Configuration" is composed by 2 Large Multiscrew Clamps for UNYCO Screws in U configuration and 8 UNYCO Screws
2. Galaxy Unyco "Long Configuration" is composed by 2 Large Multiscrew Clamps for UNYCO Screws in U configuration, 4 UNYCO Screws and 2 UNYCO Cancellous Screws
3. Competitor Z-Frame is composed by 4 bicortical screws, 3 connecting bars and 6 single clamps

Manufactured by:
 ORTHOFIX Srl
 Via Delle Nazioni 9
 37012 Bussolengo (Verona), Italy
 Telephone +39 045 6719000
 Fax +39 045 6719380

www.orthofix.com

MC-1402-PL-E0 B 06/14



Your Distributor is:

@galaxyunyco
www.galaxyunyco.com

